

X116R™

X116R FUEL WATER SEPARATOR / CATCH CAN FITMENT INSTRUCTIONS



ISUZU D-MAX, 3.0L, 07/2020 ..on / MAZDA BT50, 3.0L, (4JJ3-TCX), 08/2020 ..on

- See RYCO catalogue for specific application details. The Ryco X116R kit includes mounting brackets specifically designed for the vehicle, and all components required to complete the installation of Ryco Z980K16 series fuel water separator (FWS) and RCC360 series catch can. It is recommended that the installation is conducted by a qualified mechanic following the procedures in this instruction sheet.

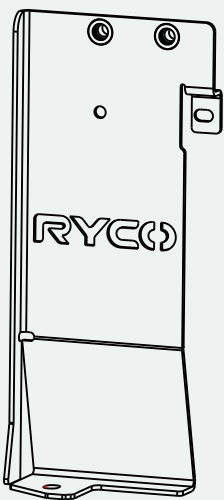

SECTION 1
FUEL WATER SEPARATOR
MOUNTING BRACKET

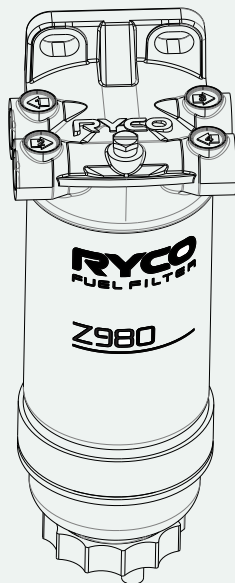

SECTION 1
FUEL WATER SEPARATOR

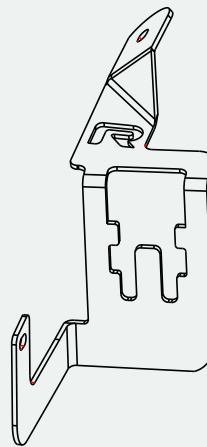

SECTION 2
CATCH CAN MOUNTING BRACKET

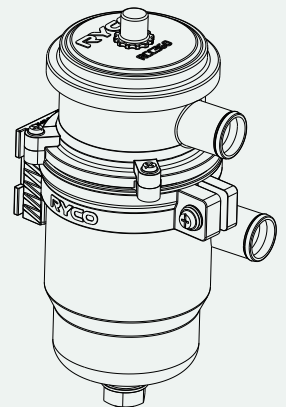

SECTION 2
CATCH CAN

COMPONENTS INCLUDED IN X116R KIT

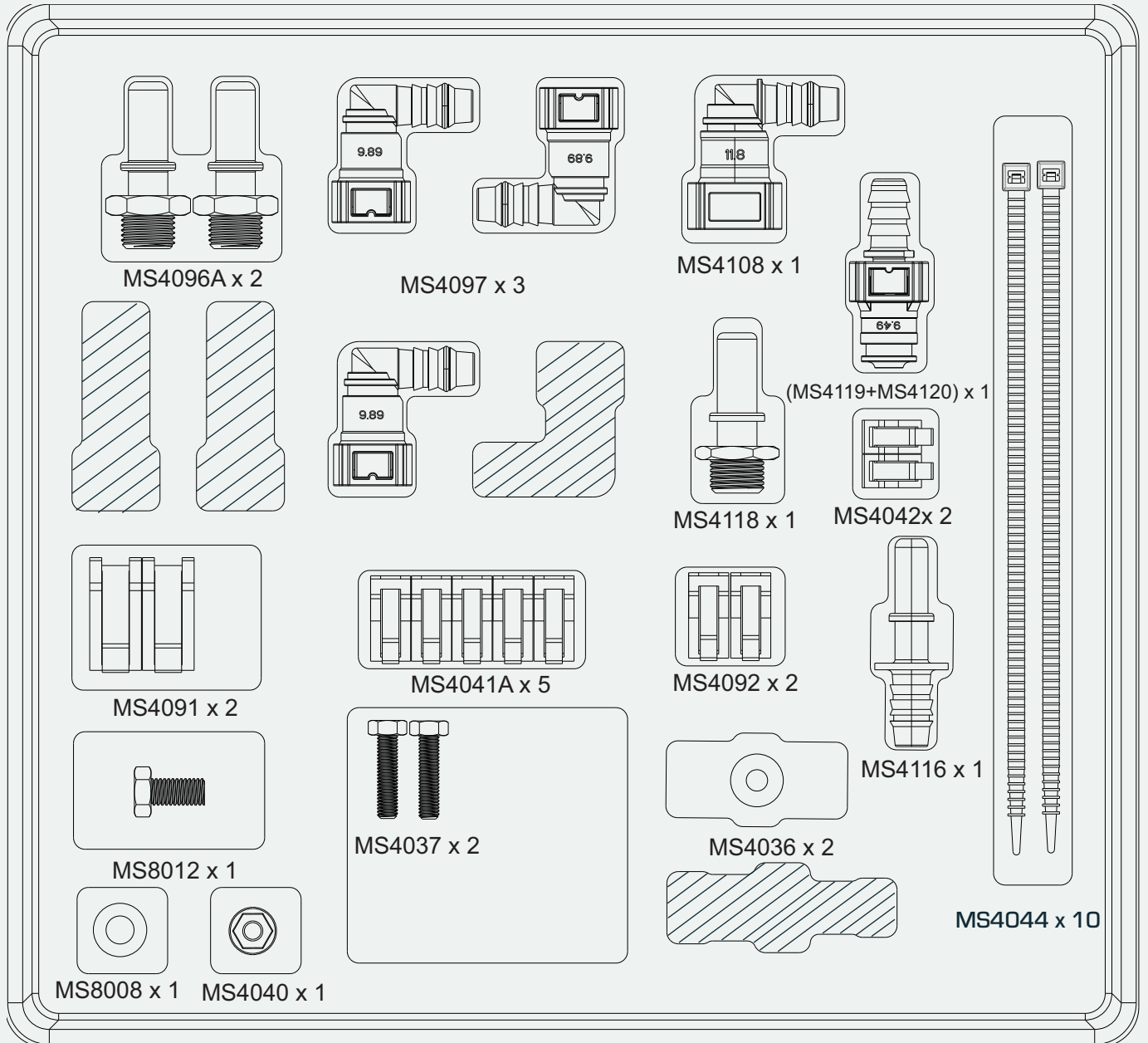

COMPONENTS INCLUDED IN X116R KIT (COMPONENTS NOT SOLD SEPARATELY)

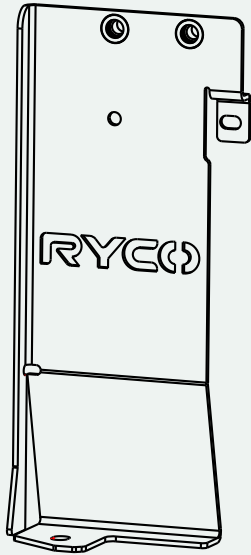

FB9816FC
FUEL WATER SEPARATOR MOUNTING BRACKET x 1

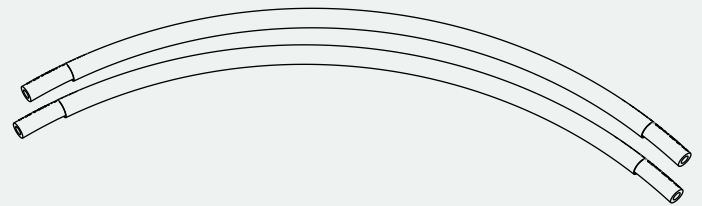

HF9816
FUEL HOSE x 2 (880 mm)

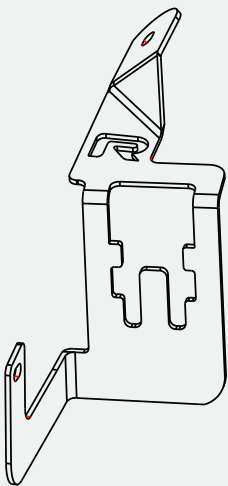

FB9816CC
CATCH CAN MOUNTING BRACKET x 1

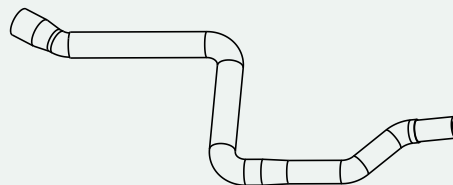

MH9816A
PCV HOSE x 1

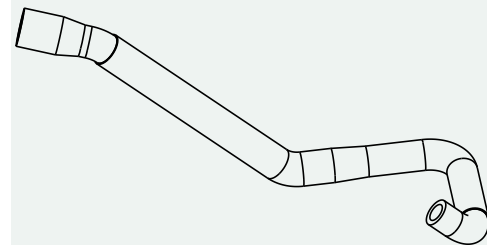

MH9816B
PCV HOSE x 1

SECTION 1A FUEL WATER SEPARATOR MOUNTING BRACKET FITMENT

PARTS REQUIRED

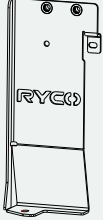

FB9816FC
Fuel Water Separator
Mounting Bracket x 1



MS8012
Hex Bolt (M8) x 1

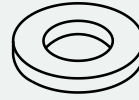

MS8008
Washer (M8) x 1



MS4040
Flange Nut (M6) x 1

TOOLS & PPE REQUIRED

- Ratchet Set
- Work Gloves

WORK PROCEDURE

- 1 Fit the Ryco Fuel Water Separator as shows in Fig. 1.
- 2 Use 1 x M6 bolt and washer (A) to secure the bottom section of the Ryco bracket.
- 3 Use 1x M8 nut and washer (B) to secure the side section of the Ryco bracket.
- 4 Tighten all the fasteners. The bracket should feel secure.

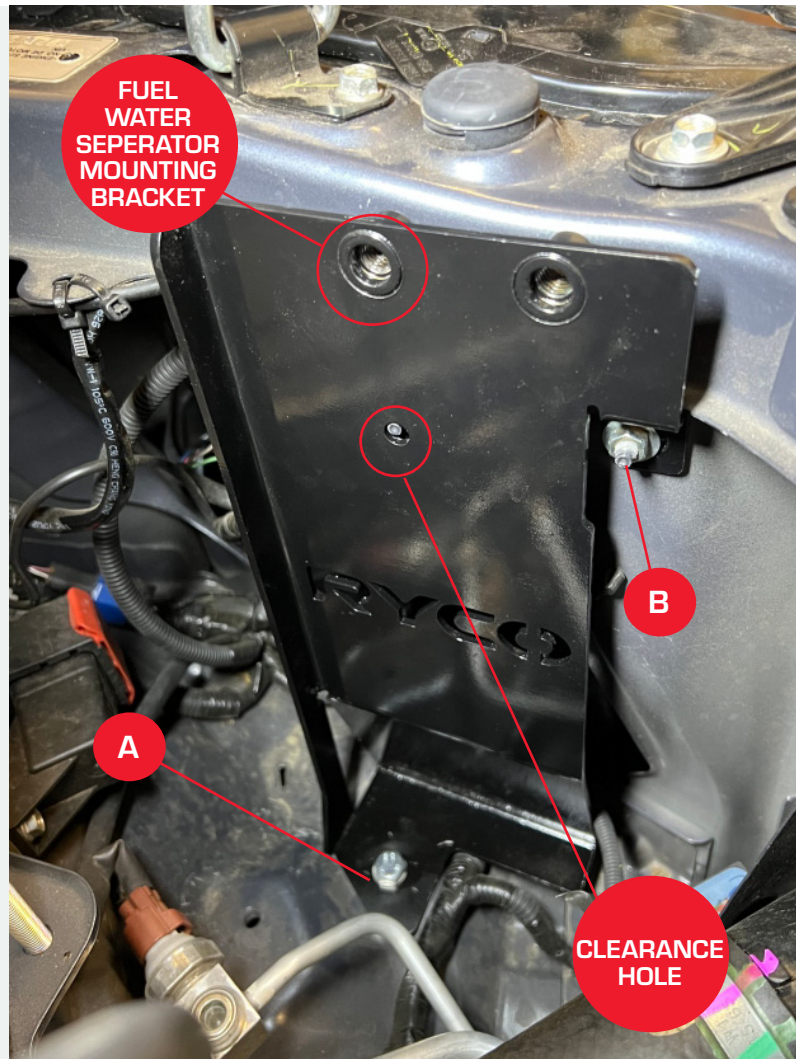
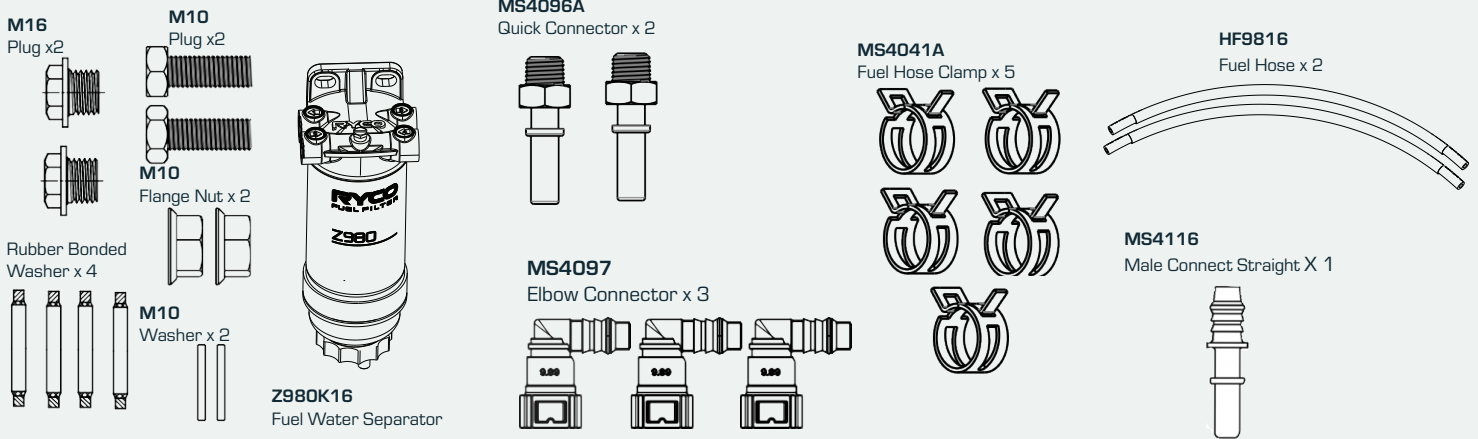

FIGURE 1A
FUEL WATER SEPERATOR MOUNTING BRACKET INSTALLATION

SECTION 1B FUEL WATER SEPARATOR INSTALLATION

PARTS REQUIRED



TOOLS & PPE REQUIRED

- Ratchet Set
- Work Gloves
- Hose Clamp Pliers
- Rags

WORK PROCEDURE

- 1 Select the supplied quick connectors that fit the Ryco fuel water separator head.
- 2 Locate the blanking plugs supplied with the fuel water separator.
- 3 Install the Ryco fuel water separator head with metal quick connectors MS4096A, blanking plugs and rubber bonded washers, as per Fig 2. Tighten blanking plugs (on Port 3 & 4) and quick connectors (on Port 1 & 2).
- 4 Install two of supplied elbow connectors MS4097 onto one end of both supplied fuel hoses and install four supplied fuel hose clamps onto both ends of fuel hoses, as per Fig. 3. Do not tighten fuel hose clamps yet.

TIP: Lubricate the barbed ends of the elbow connectors with diesel before inserting in to the hose.

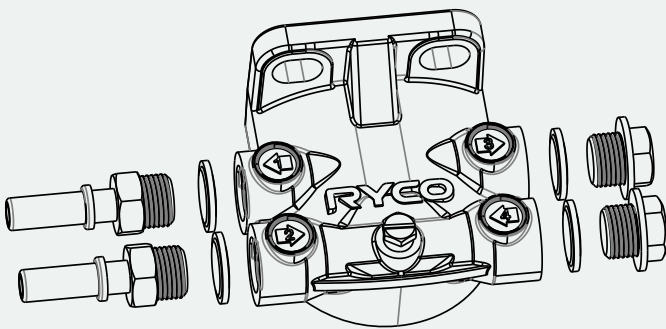

FIGURE 2
FUEL WATER SEPARATOR HEAD PREPARATION

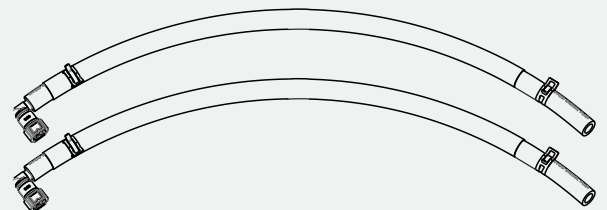

FIGURE 3
FUEL HOSE PREPARATION

SECTION 1B FUEL WATER SEPARATOR INSTALLATION

WORK PROCEDURE

- 5 Grab the factory filter housing assembly and lift up to remove from the factory bracket. Locate the fuel inlet hose at the factory fuel filter. Loosen the factory fuel hose clamp and disconnect the fuel supply line coloured blue in Fig. 5 from the factory filter. Have a rag ready to capture any diesel that may spill out of the fuel line and the fuel filter.
- 6 Fit the Ryco MS4116 fitting to the fuel supply line and secure with hose clamp.
- 7 Mount the Z980K16 fuel filter assembly onto the fuel filter bracket facing to the engine using the two (2) black M10 bolts and washers supplied with the Z980K16.

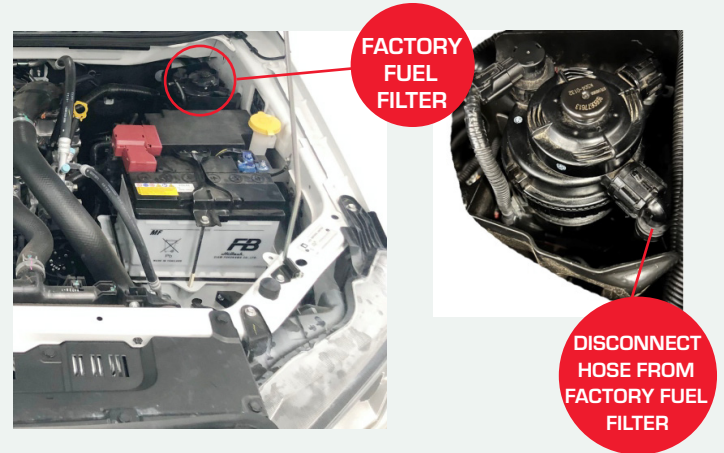

FIGURE 4
FACTORY HOSE IDENTIFICATION

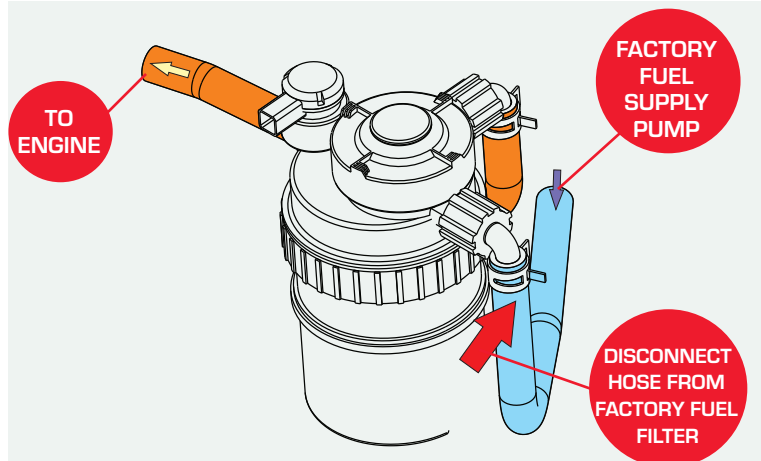

FIGURE 5
FACTORY FUEL SUPPLY HOSE

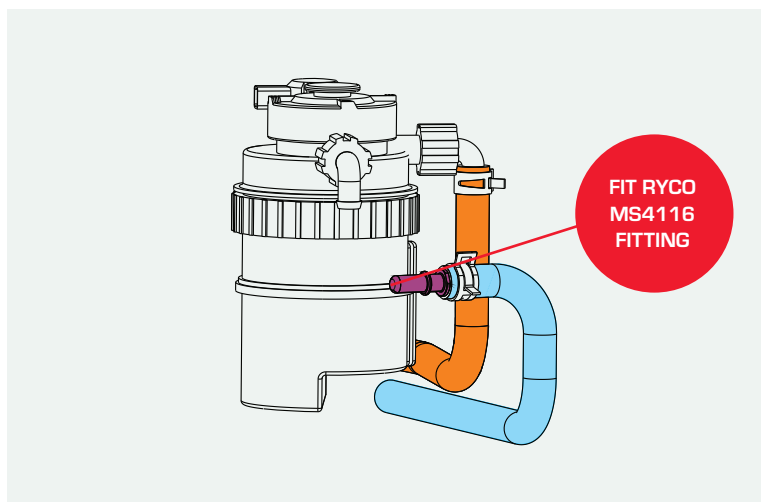

FIGURE 6
FUEL SUPPLY HOSE PREPARATION

SECTION 1B FUEL WATER SEPARATOR INSTALLATION

WORK PROCEDURE

- 8 Route a fuel hose which has been prepared in step 4, from the inlet port of the Z980K16 to the factory fuel supply hose with Ryco MS4116 fitting. (coloured blue in Fig. 7)

Install a supplied elbow connector MS4097 onto the end of the fuel hose and secure with fuel hose clamp, then connect to MS4116 fitting by pushing the elbow connector onto the supply hose quick connector until you hear a "click".

Connect the other end of the hose to the inlet port of the Z980K16 (port 2) by pushing the elbow connector onto the metal quick connector until you hear a "click" (hose coloured green in Fig. 7)

- 9 Route another fuel hose from the outlet of the Z980K16 to the factory filter inlet port as per Fig. 7 (coloured yellow), then connect the end of the fuel hose to the factory fuel filter inlet port and secure with a hose clamp.

Connect the other end of the hose to the outlet port of the Z980K16 (port 1) by pushing the elbow connector onto the metal quick connector until you hear a "click".

- 10 Slide the factory filter housing assembly back to the factory fuel filter bracket. Ensure all hose clamps are secure. Check both fuel hoses are not jammed or kinked. For added security, use the supplied cable ties to secure the fuel hoses if necessary.

- 11 Locate the priming button on top of the factory fuel filter. Prime the fuel system by pumping the button repeatedly until you feel it go hard and become difficult to press any further. The priming process could take approximately 5 - 10 minutes.

Note: DO NOT open the bleed screw on the Z980K16 during the priming process.

- 12 Once the fuel system has been primed, start the engine. Check for any leaks.

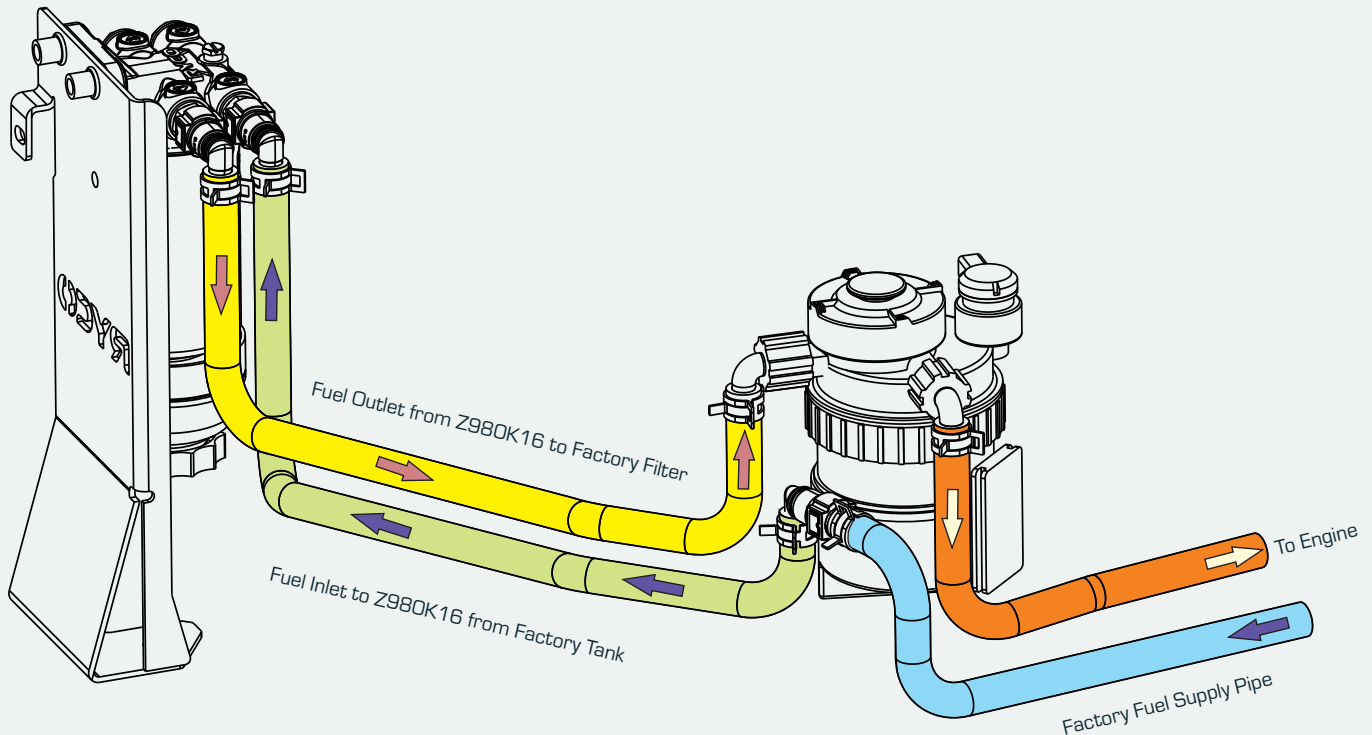
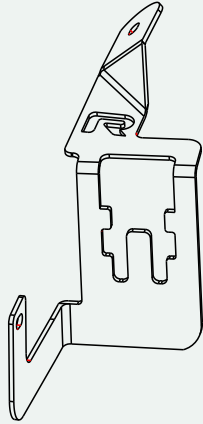

FIGURE 7
HOSE INSTALLATION

SECTION 2A CATCH CAN MOUNTING BRACKET FITMENT

PARTS REQUIRED

FB9816CC
Catch Can Mounting Bracket x 1



MS4037
Hex Bolt x 2 (M6)

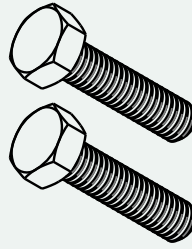

MS4036
Washer x 2 (M6)



TOOLS & PPE REQUIRED

- Ratchet Set
- Work Gloves
- Hose Clamp Pliers

WORK PROCEDURE

- 1 Locate the bracket mounting position on the driver's side of the engine bay as shown in Fig.1, then remove the factory bolt (X in Fig. 8)
- 2 Fit the Ryco Catch Can mounting bracket, and install supplied bolt and washer (position A & B in Fig. 9).
- 3 Ensure all fasteners are tight.



FIGURE 8
CATCH CAN BRACKET POSITION AT ENGINE BAY

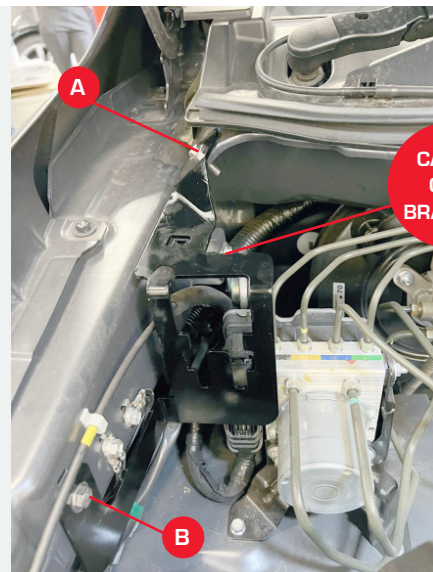
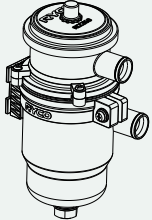

FIGURE 9
BRACKET INSTALLATION

SECTION 2B CATCH CAN INSTALLATION

PARTS REQUIRED

RCC360
Catch Can



MH9816A
PCV Hose x 1

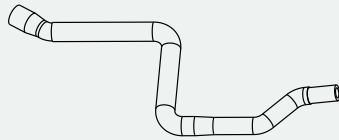

MH9816B
PCV Hose x 1

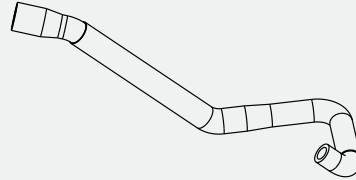

MS4091
PCV Hose Clamp x 2



MS4092
PCV Hose Clamp x 2



TOOLS & PPE REQUIRED

- Ratchet Set
- Work Gloves
- Hose Clamp Pliers

WORK PROCEDURE

- 1 Mount the catch can onto the bracket by sliding the RCC360 onto the catch can mounting position so the ports are facing toward the engine and slightly forward. Tighten the plastic bracket retaining screw on the RCC360.
- 2 Remove the engine cover. Locate the engine PCV valve outlet port at the front of the engine (see Fig. 3). Remove the factory PCV hose (coloured orange in Fig. 10).

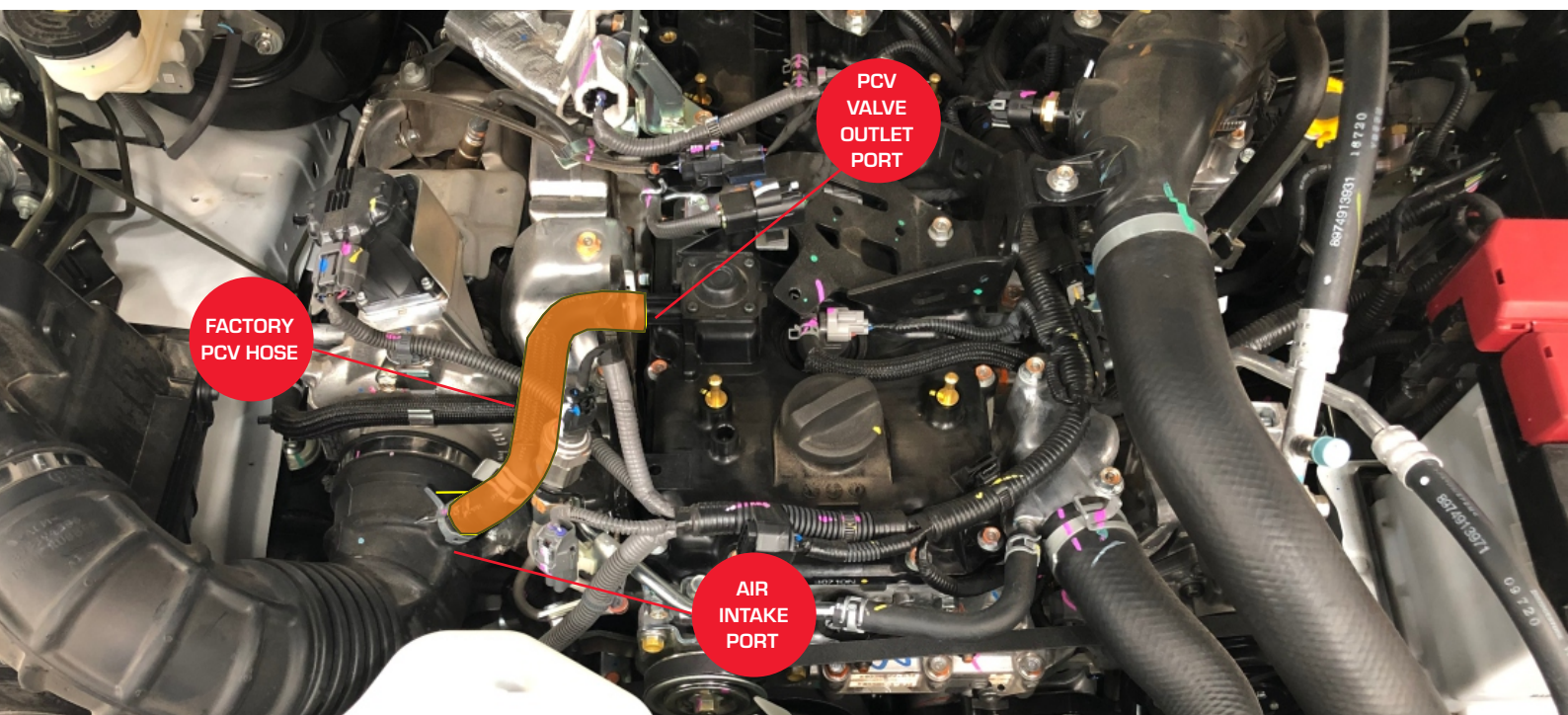

FIGURE 10
FACTORY PCV HOSE POSITION AT ENGINE BAY

SECTION 2B CATCH CAN INSTALLATION

WORK PROCEDURE

- 3 Connect the small end of Ryco PCV hose MH9816A (coloured blue in Fig. 5) to the engine PCV valve outlet using the supplied hose clamp MS4092. Connect the larger diameter end to the lower port of the RCC360. Secure with the supplied hose clamp MS4091.
- 4 Connect the small end of MH9816B to the air intake return port (coloured yellow in Fig. 5, page 7) and secure with a supplied hose clamp, then connect the large diameter end to the upper port of the RCC360 and secure with a supplied hose clamp MS4091.
- 5 Check both PCV hoses are not jammed or kinked by the surrounding engine parts.

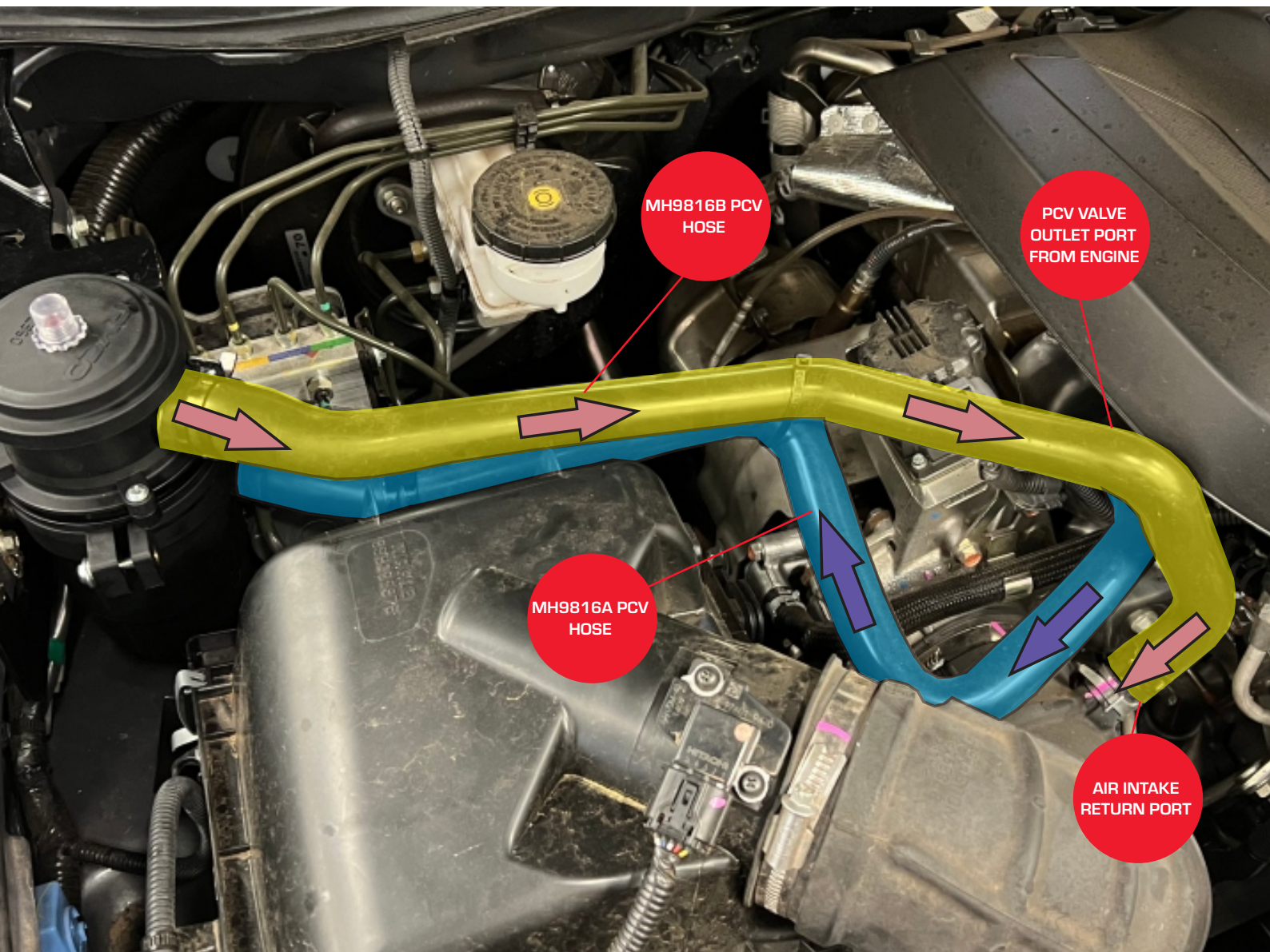
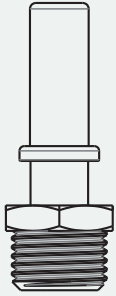
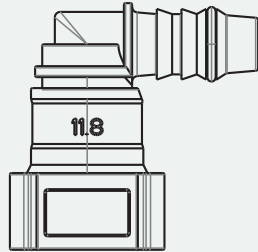

FIGURE 11
CATCH CAN INSTALLATION

INCLUDED DRAIN HOSE COMPONENTS



MS4118
QUICK CONNECTOR x 1



MS4108
ELBOW QUICK CONNECTOR x 1

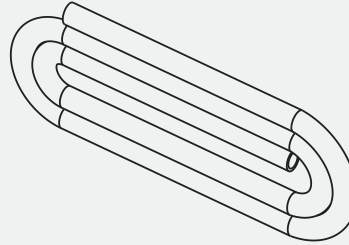

MS4117
PVC HOSE x 1M



MS4119 + MS4120
HOSE END PLUG x 1 SET

DRAIN HOSE INSTALLATION PROCEDURE

TO INSTALL THE DRAIN HOSE

- 1 Remove the blanking plug from the base of the catch can.
- 2 Remove the rubber washer from the blanking plug.
- 3 Fit rubber washer to the MS4118 Male Quick Connector.
- 4 Install MS4118 with rubber washer to the base of catch can.
- 5 Connect the MS4108 elbow female quick connector to the MS4118 male quick connector on the base of the catch can by pushing on until you hear a "click".
- 6 Insert the drain hose onto the barb end of MS4108 and secure with the supplied spring clamp.
- 7 Insert the MS4119 onto the other end of the hose and secure with the supplied spring clamp.
- 8 Use the zip ties to secure the hose.

DRAIN HOSE INSTALLATION

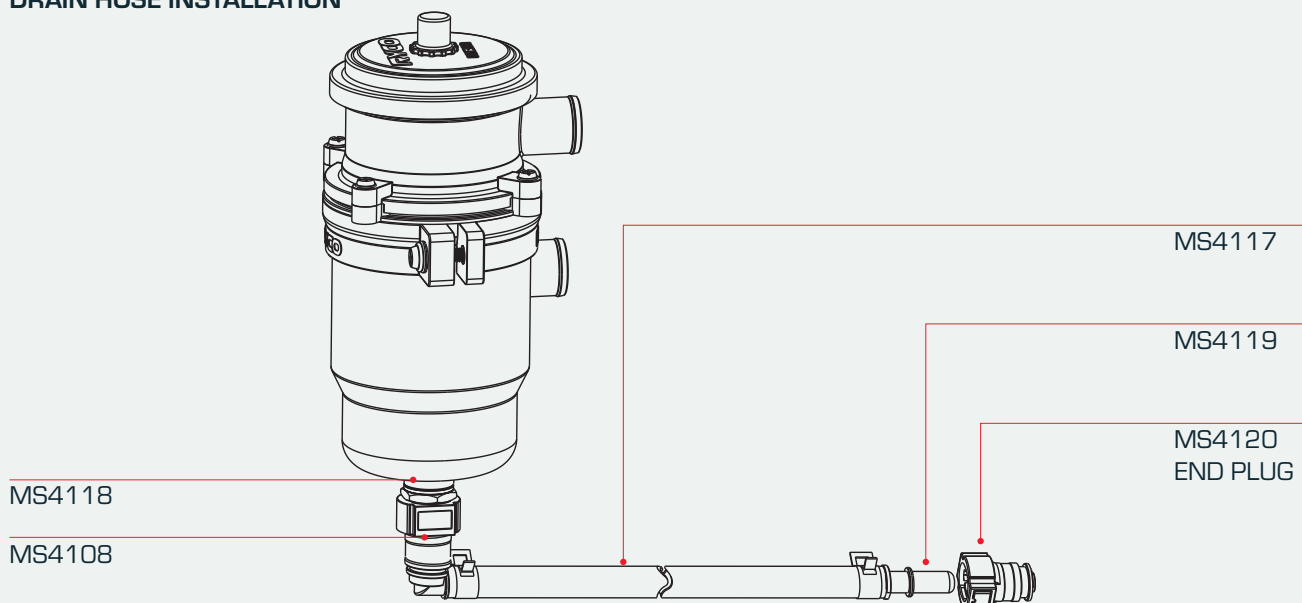

HOW TO DRAIN THE CATCH CAN

Note: Check the catch can sump level every month or 5000km, whichever comes first and drain as required. Sump level checks are recommended daily when four-wheel driving or towing.

IF THE DRAIN HOSE IS FITTED

- 1 Push both buttons on the MS4120 end plug and pull to separate from the MS4119.
- 2 Allow all oil to drain out.
- 3 Push MS4120 plug back on to MS4119 until you hear a "click".

IF FITTED WITHOUT DRAIN HOSE

- 1 Slide the catch can out of the bracket. You may need to remove inlet and outlet hoses by loosening the hose clamps.
- 2 Remove the blanking plug from the base of the catch can.
- 3 Allow all oil to drain.
- 4 Refit the blanking plug to the base of the catch can ensure the rubber seal is in place.

WHEN SHOULD YOU SERVICE THE CATCH CAN

CHECK SERVICE INDICATOR

If red service indicator is not raised, the catch can does not currently require a service. Check again in a month or 5000 km. Sump level checks are recommended daily when four-wheel driving or towing. If the red service indicator is raised, unscrew the clear service indicator housing and compress the red service indicator. Run the engine and if the red service indicator raises again, it is time to service your catch can.

NO SERVICE REQUIRED



SERVICE REQUIRED



HOW TO DRAIN THE CATCH CAN

- 1 Draining catch can before service is recommended.
- 2 Undo the four bolts the on the catch can head, take note of outlet position. Remove hoses and clamps, if required.
- 3 Separate the head from the rest of the catch can.
- 4 Lift out old filter.
- 5 Use a rag to clean inside catch can sump.
- 6 Refit new filter (RCC160F), and replace the main housing o-ring.
- 7 Reinstall the filter head noting the position of the outlet port from earlier.
- 8 Tighten the four bolts and reinstall hoses and hose clamps if removed.

X116R™

X116R FUEL WATER SEPARATOR / CATCHCAN FITMENT INSTRUCTIONS